

# DURACELL®

## MN2400

### Size: AAA (LR03)

Alkaline-Manganese Dioxide Battery

Zn/MnO<sub>2</sub>

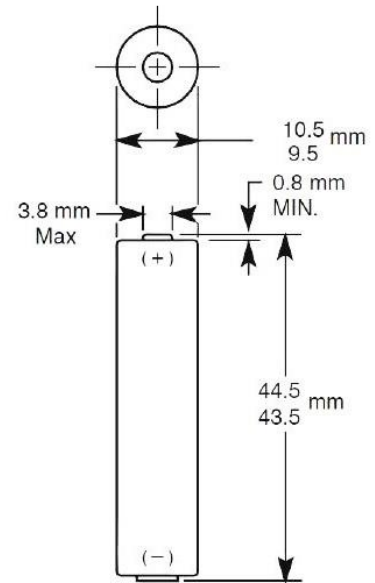

Dimensions shown are ANSI standards

<b>Nominal voltage</b>	1.5 V
<b>Impedance</b>	250 m-ohm @ 1 kHz
<b>Typical weight</b>	11.7 g (0.41 oz)
<b>Typical volume</b>	3.5 cm <sup>3</sup> (0.21 in <sup>3</sup> )
<b>Terminals</b>	Flat
<b>Storage temperature range</b>	5°C to 30°C (41°F to 86°F)
<b>Operating temperature range</b>	-20°C to 54°C (-4°F to 130°F)
<b>Designation</b>	<b>ANSI: 24A IEC: LR03</b>

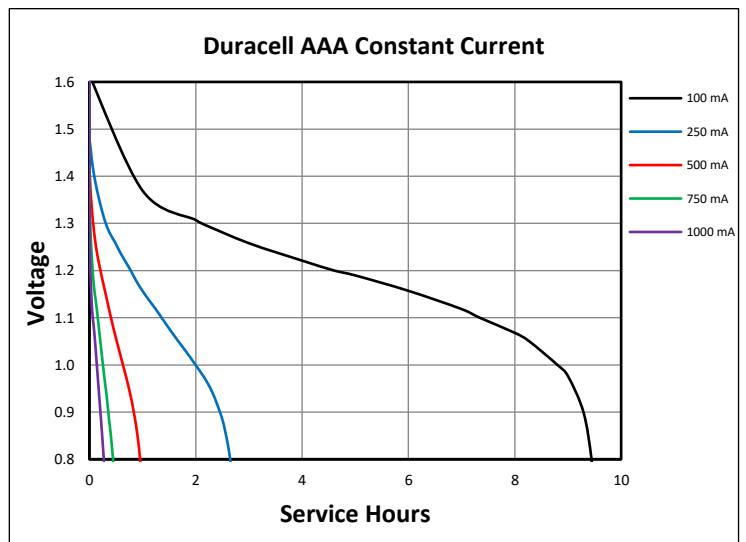
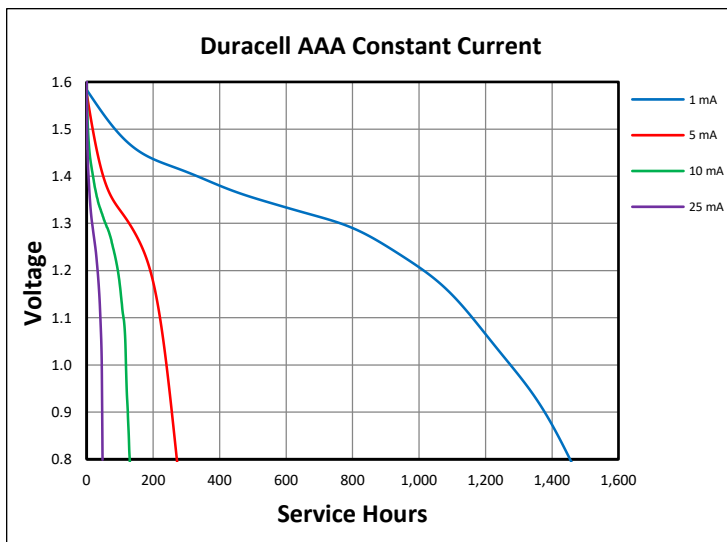

# DURACELL®

BATTERIES

Berkshire Corporate Park  
Bethel, CT. 06801 U.S.A.  
Telephone: Toll-free 1-800-544-5454  
www.duracell.com

Delivered capacity is dependent on the applied load, operating temperature and cut-off voltage. Please refer to the charts and discharge data shown for examples of the energy/service life that the battery will provide for various load conditions.

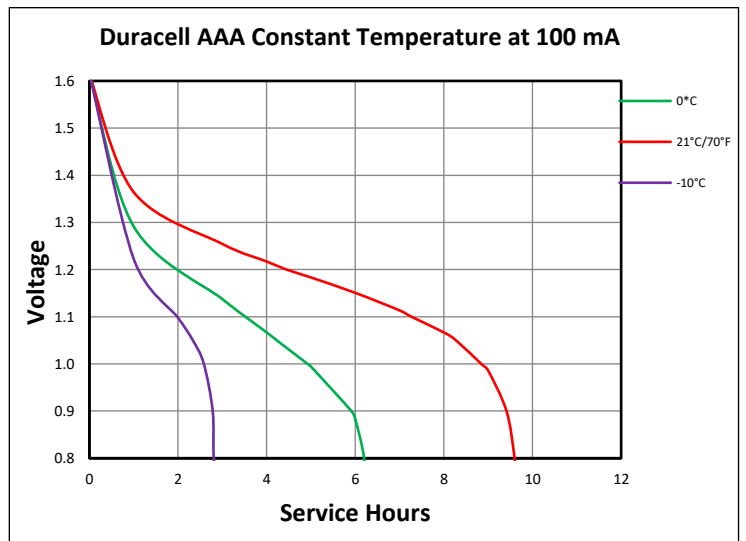
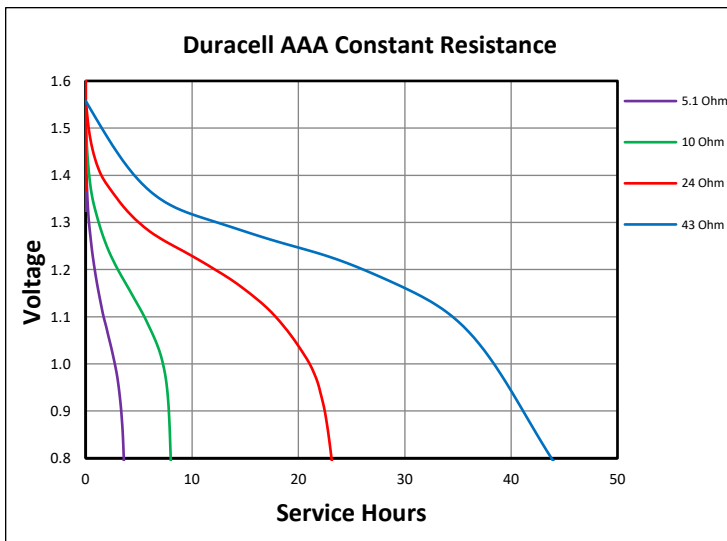
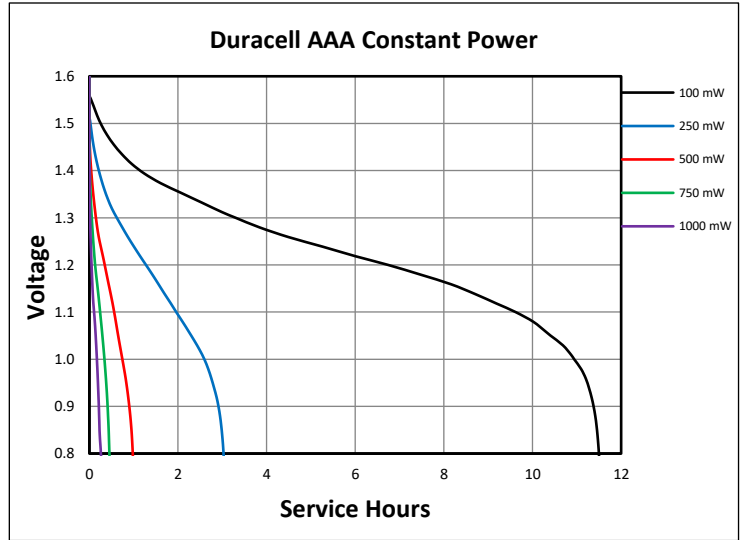
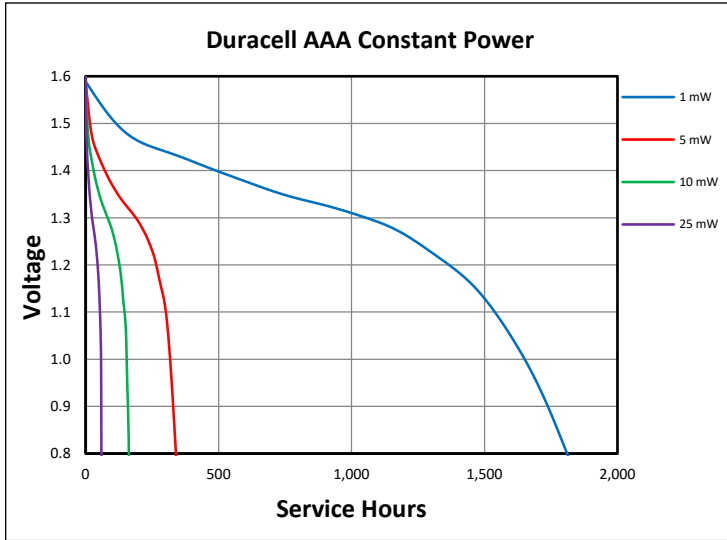

# DURACELL®

BATTERIES

Berkshire Corporate Park  
Bethel, CT. 06801 U.S.A.  
Telephone: Toll-free 1-800-544-5454  
www.duracell.com

Delivered capacity is dependent on the applied load, operating temperature and cut-off voltage. Please refer to the charts and discharge data shown for examples of the energy/service life that the battery will provide for various load conditions.