

LC-QA1224P

DIMENSIONS (MM)

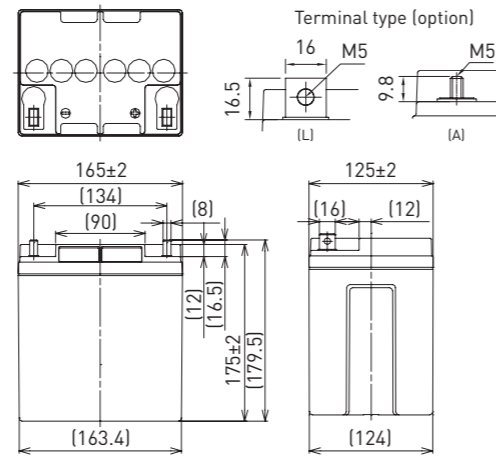

FOR STANDBY POWER SUPPLIES.
EXPECTED TRICKLE DESIGN LIFE: 15 YEARS AT 20°C.



Contents indicated (including the recycle marking, etc.) are subject to change without notice.

Battery case resin: flame retardant (UL94 V-0)

SPECIFICATIONS

Name	LC-QA1224P/AP	
Nominal voltage	12V	
Nominal capacity (20 hour rate)	24Ah	
Dimensions	Length	165mm
	Width	125mm
	Height	175mm
Approx. mass	9.9kg	
Terminal	M5 bolt/nut & threaded post	
	20 hour rate	27Ah
	10 hour rate	25Ah
Capacity (25°C)	3 hour rate	20Ah
	1 hour rate	16Ah
	Impedance	Fully charged battery (25°C)
8mΩ		
Temperature dependency of capacity (20 hour rate)	40°C	102%
	25°C	100%
	0°C	85%
	-15°C	65%
Self-discharge (25°C)	After 3 month	91%
	After 6 month	82%
	After 12 month	64%

DURATION OF DISCHARGE VS. DISCHARGE CURRENT

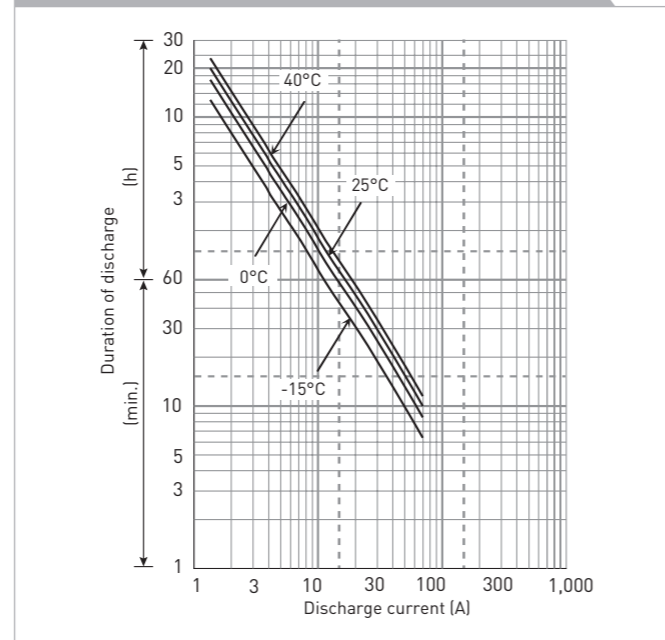

WATT TABLE (25°C)

Cut-off	(Wattage/battery)													
	10min.	15min.	20min.	30min.	45min.	1h	1.5h	2h	3h	4h	5h	6h	10h	20h
9.6V	773	605	521	401	280	215	167	113	79.9	65.8	51.8	46.8	27.0	13.5
9.9V	760	600	512	396	274	210	163	112	79.7	65.3	50.9	46.0	26.8	13.5
10.2V	746	591	503	390	268	205	159	111	79.3	64.7	50.1	45.3	26.4	13.4
10.5V	724	575	479	372	261	200	155	107	78.2	64.0	49.7	44.8	26.1	13.3
10.8V	701	558	456	344	256	196	152	104	77.1	63.2	49.5	44.3	25.9	13.3

AMPERE TABLE (25°C)

Cut-off	(Ampere/battery)													
	10min.	15min.	20min.	30min.	45min.	1h	1.5h	2h	3h	4h	5h	6h	10h	20h
9.6V	72.6	51.2	42.8	30.5	22.4	17.4	11.3	9.90	6.98	5.51	4.50	3.83	2.48	1.35
9.9V	70.3	50.1	42.3	30.3	21.8	17.0	11.2	9.79	6.86	5.46	4.41	3.71	2.48	1.35
10.2V	67.7	49.2	41.3	30.0	21.4	16.7	11.1	9.68	6.75	5.40	4.36	3.69	2.48	1.35
10.5V	64.9	47.3	39.5	29.3	20.3	15.8	11.0	9.56	6.64	5.29	4.32	3.65	2.48	1.35
10.8V	63.8	46.4	38.8	28.2	18.0	13.8	10.3	9.00	6.41	5.18	4.28	3.60	2.48	1.35

All mentioned values are average values

LC-QA1224P

CHARGING METHOD (25°C)

Trickle use Control voltage: 13.6V - 13.8V
Initial current: 3.60A or smaller

CUT-OFF VOLTAGE

Discharge current	1.20A - 4.80A	4.80A - 12.0A	12.0A - 24.0A	24.0A - 48.0A	48.0A - 72.0A
Cut-off voltage	10.5V	10.2V	9.9V	9.3V	8.7V

INFLUENCE OF TEMPERATURE ON TRICKLE LIFE

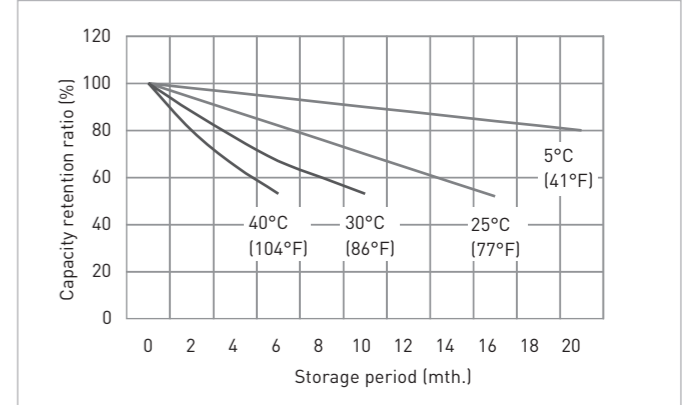
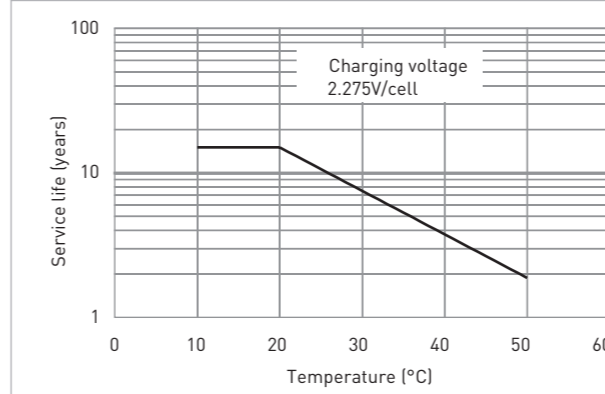

CONSTANT-VOLTAGE CONSTANT-CURRENT CHARGE CHARACTERISTICS FOR TRICKLE USE

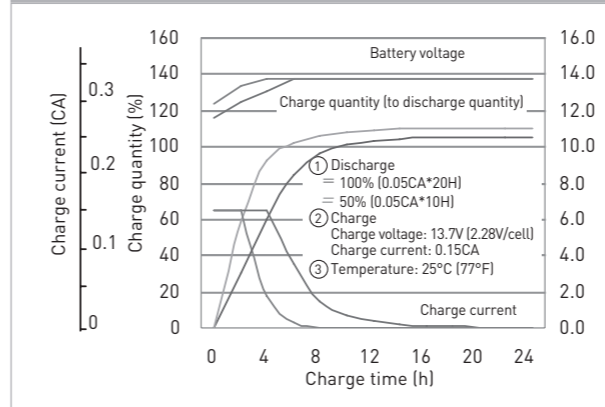

DISCHARGE CAPACITY BY TEMPERATURE AND BY DISCHARGE CURRENT

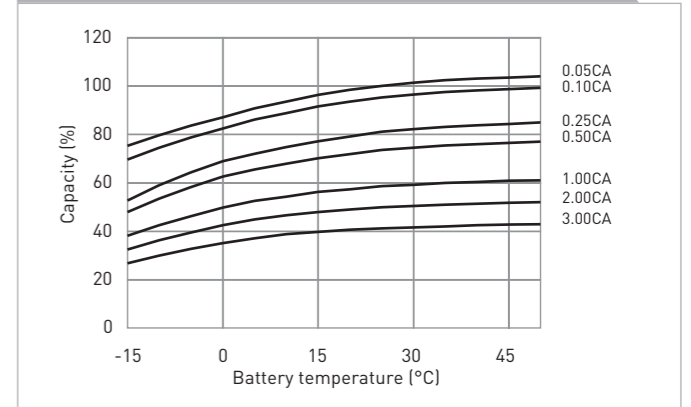

DISCHARGE CHARACTERISTICS

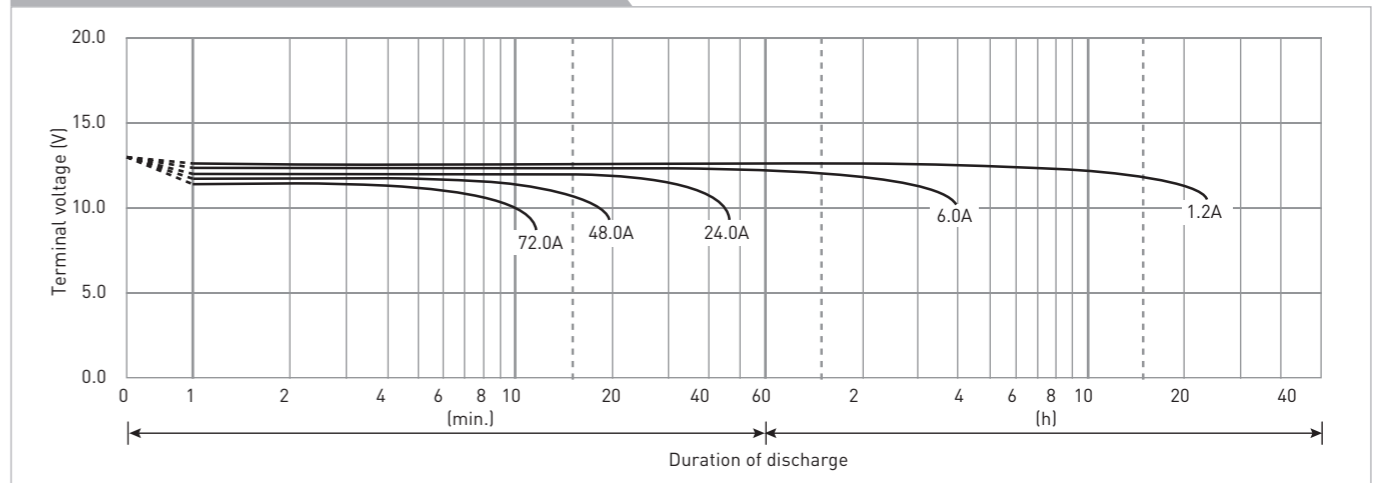

The data in this document are for descriptive purposes only and are not intended to make or imply any guarantee or warranty. Regarding handling and safety please consult our VRLA technical handbook chapter 1.