

LC-CA1215P

DIMENSIONS (MM)

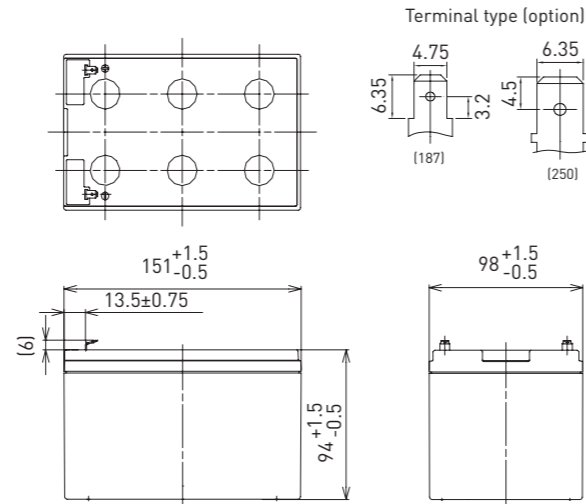

FOR MAIN POWER SUPPLIES.
CYCLE LONG-LIFE TYPE



Battery case resin: standard (UL94 HB)

Contents indicated (including the recycle marking, etc.) are subject to change without notice.

SPECIFICATIONS

Name	LC-CA1215P/P1
Nominal voltage	12V
Nominal capacity (20 hour rate)	15Ah
Dimensions	Length 151mm
	Width 98mm
	Height 100mm
Approx. mass	4.20kg
Terminal	Faston 187/250
Capacity (25°C)	20 hour rate 15Ah
	10 hour rate 13Ah
	3 hour rate 12Ah
	1 hour rate 10Ah
Impedance	Fully charged battery (25°C) 15mΩ
	Temperature dependency of capacity (20 hour rate)
Self-discharge (25°C)	40°C 102%
	25°C 100%
	0°C 85%
	-15°C 65%
Self-discharge (25°C)	After 3 month 91%
	After 6 month 82%
	After 12 month 64%

DURATION OF DISCHARGE VS. DISCHARGE CURRENT

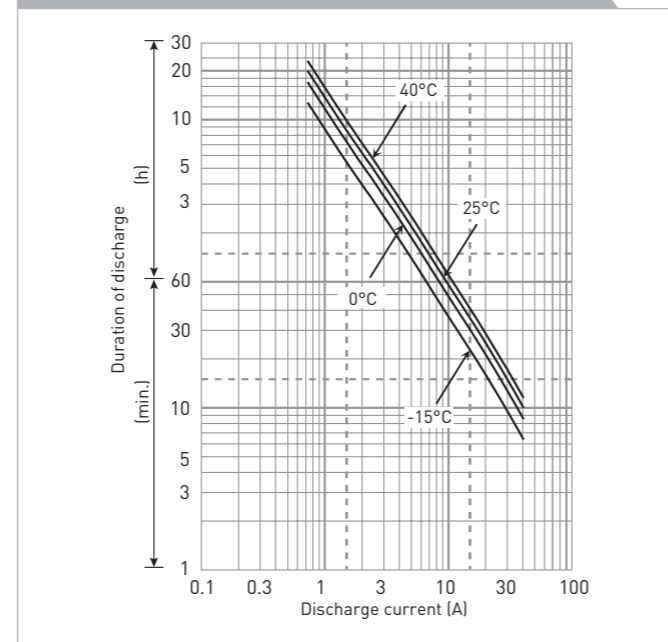

WATT TABLE (25°C)

Cut-off	(Wattage/battery)															
	3min.	5min.	10min.	15min.	20min.	30min.	45min.	1h	1.5h	2h	3h	4h	5h	6h	10h	20h
9.6V	850	682	455	350	292	217	157	123	83.9	65.0	47.1	36.0	29.9	25.2	16.2	8.75
9.9V	799	646	444	343	286	213	156	122	82.8	64.6	46.9	35.8	29.7	25.1	16.1	8.74
10.2V	741	607	433	336	281	211	154	121	81.4	63.4	46.4	35.7	29.5	24.9	15.9	8.72
10.5V	667	555	404	318	270	206	152	118	80.1	61.9	45.7	35.5	29.4	24.8	15.8	8.70
10.8V	576	497	368	300	263	199	146	116	77.7	59.6	44.8	35.1	28.9	24.5	15.7	8.66

AMPERE TABLE (25°C)

Cut-off	(Ampere/battery)															
	3min.	5min.	10min.	15min.	20min.	30min.	45min.	1h	1.5h	2h	3h	4h	5h	6h	10h	20h
9.6V	76.5	61.2	40.6	30.4	25.2	18.5	13.4	10.5	7.11	5.49	3.96	3.01	2.49	2.10	1.35	0.755
9.9V	71.8	58.0	39.7	29.9	24.7	18.2	13.3	10.4	7.01	5.45	3.94	3.00	2.48	2.09	1.34	0.753
10.2V	66.6	54.5	38.6	29.2	24.2	18.1	13.1	10.3	6.89	5.36	3.90	2.99	2.46	2.08	1.33	0.752
10.5V	59.9	49.8	36.1	27.6	23.3	17.6	13.0	10.0	6.78	5.22	3.84	2.97	2.45	2.07	1.32	0.750
10.8V	51.8	44.6	32.9	26.1	22.7	17.0	12.5	9.82	6.58	5.03	3.77	2.94	2.41	2.04	1.31	0.747

All mentioned values are average values

LC-CA1215P

CHARGING METHOD (25°C)

Cycle use Control voltage: 14.5V - 14.9V
Initial current: 6.00A or smaller

CUT-OFF VOLTAGE

Discharge current	0.750A - 3.00A	3.00A - 7.50A	7.50A - 15.0A	15.0A - 30.0A	30.0A - 45.0A
Cut-off voltage	10.5V	10.2V	9.9V	9.3V	8.7V

CYCLE LIFE VS. DEPTH OF DISCHARGE (ACC. IEC 61056)

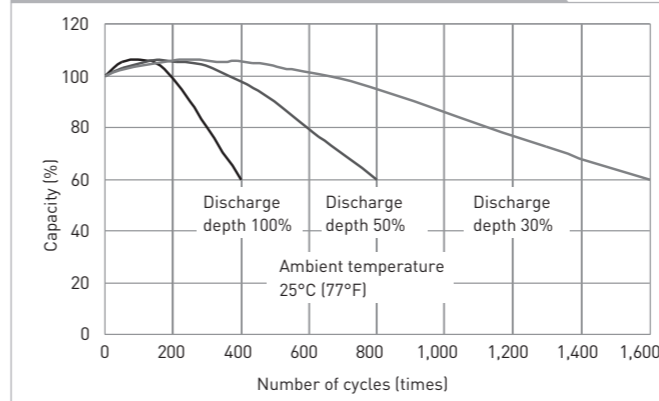

RESIDUAL CAPACITY TEST RESULT

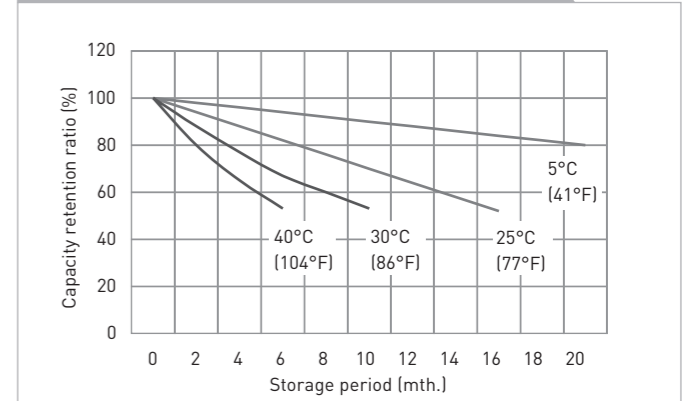

CONSTANT-VOLTAGE CONSTANT-CURRENT CHARGE CHARACTERISTICS FOR CYCLE USE

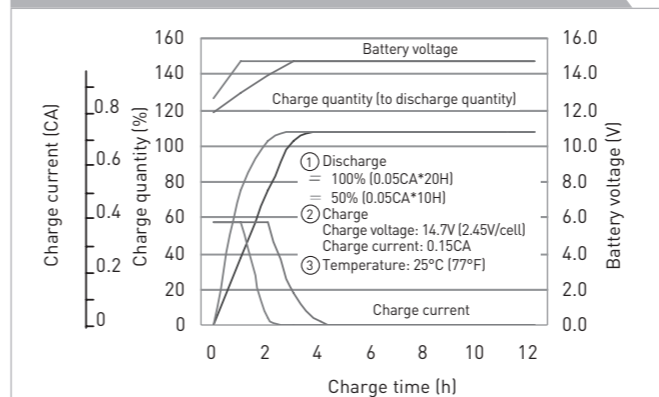

DISCHARGE CAPACITY BY TEMPERATURE AND BY DISCHARGE CURRENT

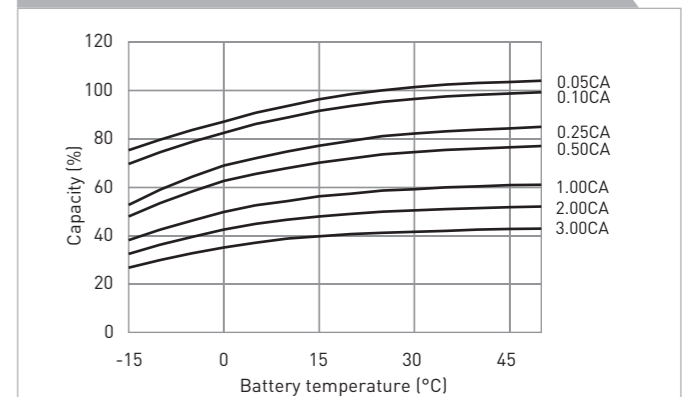

DISCHARGE CHARACTERISTICS

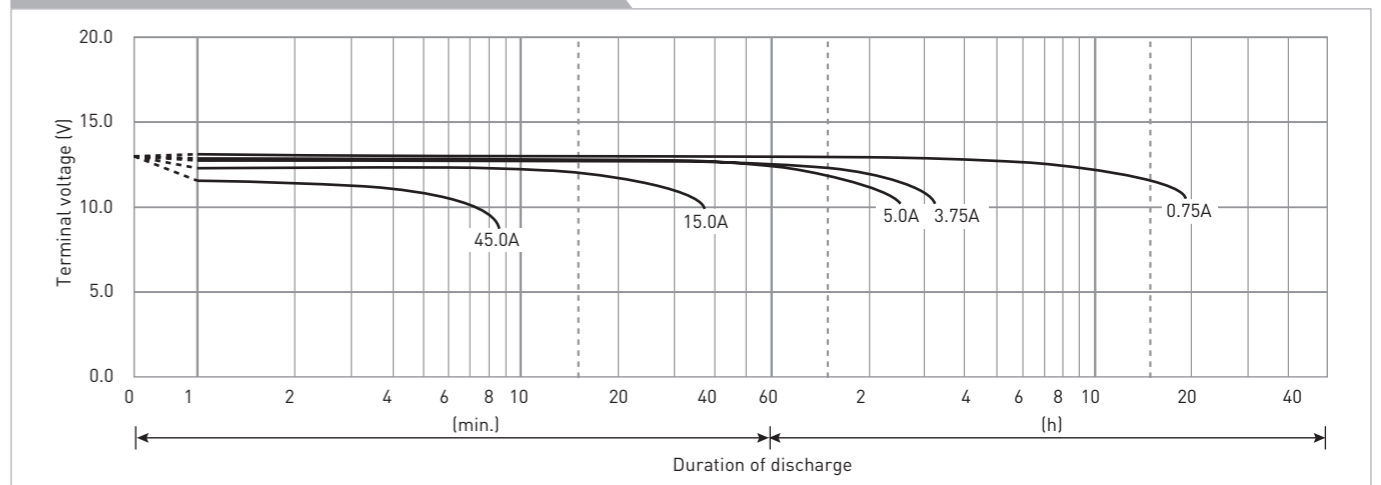

The data in this document are for descriptive purposes only and are not intended to make or imply any guarantee or warranty. Regarding handling and safety please consult our VRLA technical handbook chapter 1.