

Panasonic

ideas for life

LC-P12200

For standby power supplies
 Expected trickle life: 6 years at 25°C
 10 years at 20°C



※Contents indicated (including the recycle marking, etc) are subject to change without notice.

■Dimensions(mm)

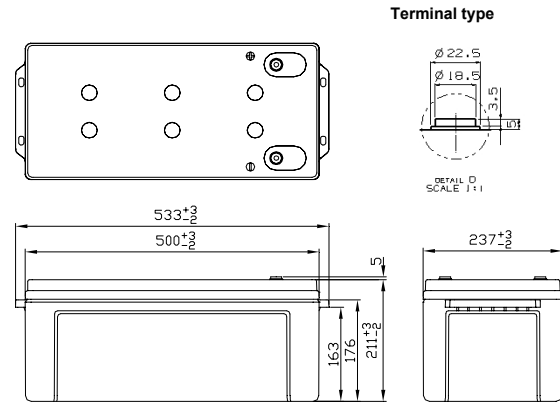

Battery case resin: Flame-retardant (UL94V-0)

■Specifications

Nominal Voltage		12V
Rated Capacity(20HR)		200Ah
Dimensions	Length	533 mm
	Width	237 mm
	Height	211 mm
	Total height	216 mm
Approx. Mass		57.0 kg
Terminal		M8 threaded insert

■Characteristics

Capacity (25 °C)	20 hour rate	200Ah
	10 hour rate	185Ah
	3 hour rate	169Ah
	1 hour rate	118Ah
Internal Resistance (25 °C)	Fully charged battery	2.5 mΩ
Temperature Dependency of Capacity (20 hour rate)	40 °C	102%
	25 °C	100%
	0 °C	85%
	-15 °C	65%
Self Discharge (25 °C)	After 3 months	91%
	After 6 months	82%
	After 12 months	64%

■Duration of discharge vs. discharge current

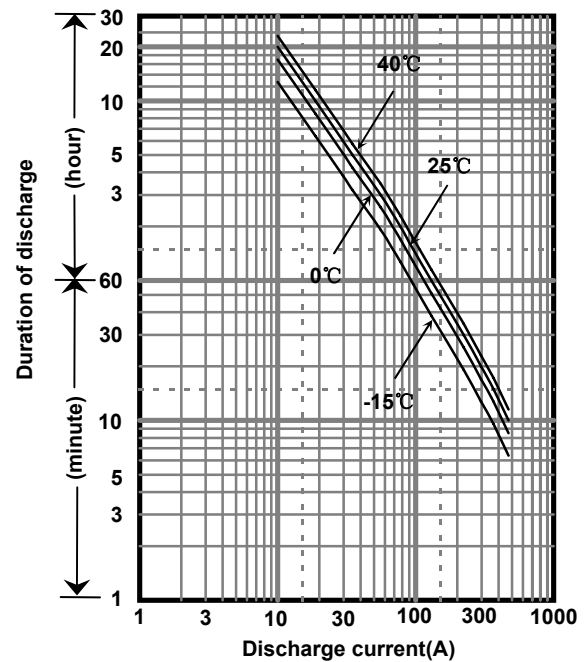

■Watt Table(25°C)

Cut-off V	5min	10min	15min	20min	30min	45min	1h	1.5h	2h	3h	4h	5h	6h	10h	20h
9.6V	6577	5182	4285	3512	2651	1863	1505	1106	917	668	524	432	369	235	129
9.9V	6427	5052	4264	3491	2577	1807	1478	1105	893	660	512	420	363	234	128
10.2V	5643	4649	3966	3175	2352	1674	1336	965	837	618	483	401	333	222	128
10.5V	5092	4390	3851	3085	2308	1634	1296	925	821	608	475	396	331	221	128
10.8V	4462	3876	3725	3017	2253	1573	1246	877	800	592	464	388	325	220	128

■Ampere Table(25°C)

Cut-off V	5min	10min	15min	20min	30min	45min	1h	1.5h	2h	3h	4h	5h	6h	10h	20h
9.6V	655	471	366	297	222	163	130	95.7	86.0	59.6	45.6	37.0	30.2	19.0	10.1
9.9V	640	460	357	290	217	159	126	92.3	84.6	58.5	44.8	36.1	29.8	18.9	10.1
10.2V	564	425	346	281	210	154	121	87.7	83.0	57.3	43.7	35.3	29.2	18.8	10.0
10.5V	509	401	336	273	206	150	118	84.1	81.5	56.4	43.0	34.9	29.0	18.7	10.0
10.8V	446	354	325	267	201	145	113	79.7	79.4	54.9	42.0	34.1	28.4	18.5	9.99

All mentioned values are average values

Charging Method (25°C)

Trickle use	Control voltage:13.6-13.8V Initial current:30.0A or smaller
-------------	--

Cut off voltage

Discharge current	10.0A-40.0A	40.0A-100A	100A-200A	200A-400A	400A-600A
Cut off voltage(V)	10.5	10.2	9.9	9.3	8.7

Influence of Temperature on Trickle life

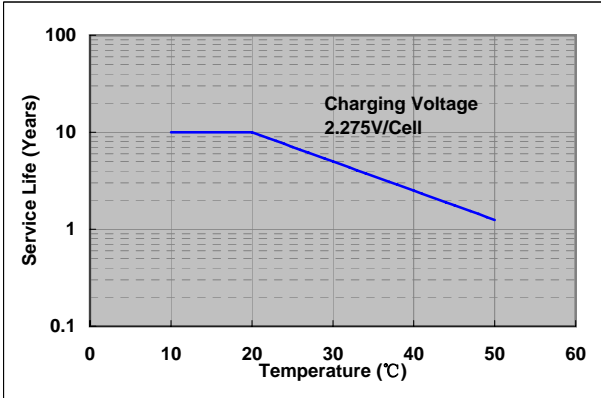

Residual capacity test result

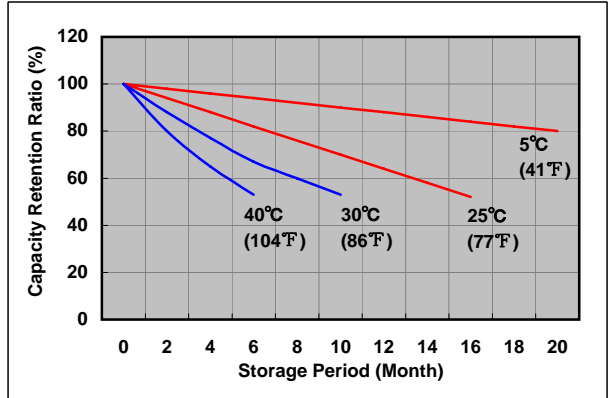

Constant-voltage constant-current charge characteristics for Trickle use

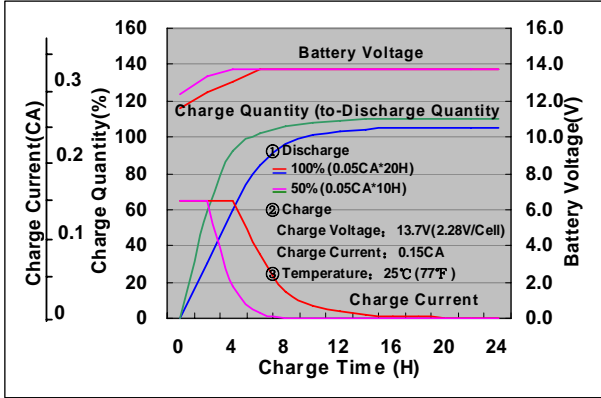

Discharge capacity by temperature and by discharge current

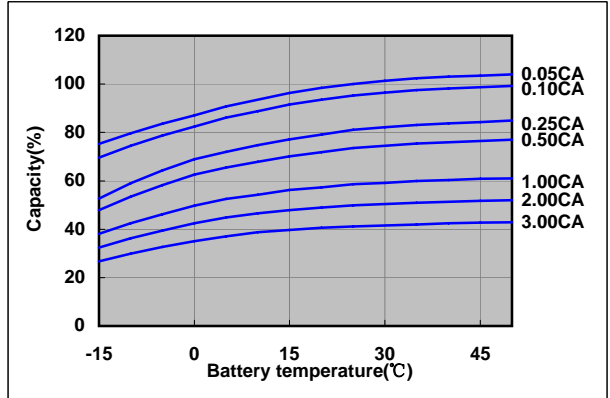

Discharge characteristics(25°C)

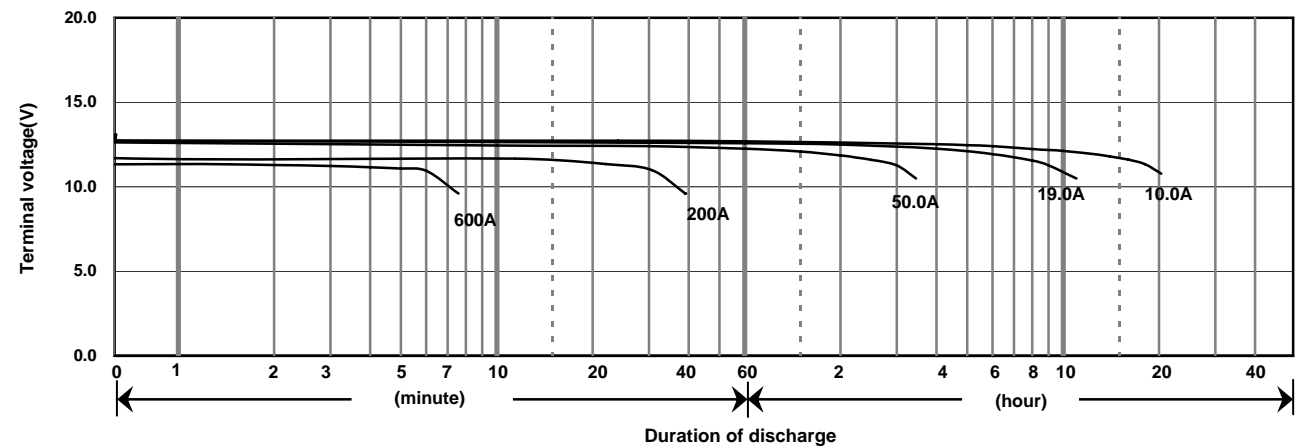

Caution

Due to the potential energy stored in the batteries, Please read 《Precautions for handling the Rechargeable Valve Regulated Lead Acid Batteries》 before using batteries. If improper handling or use of the batteries without understanding 《Precautions for handling the Rechargeable Valve Regulated Lead Acid Batteries》 may result in bodily injury caused by electrolyte leakage, heat generation, or explosion.

Panasonic Storage Battery (Shenyang) Co., Ltd

NO. 51 Kunminghu Street, Shenyang Economic & Technical Development Zone, 110141 China
Tel: 86 24 25818921
Fax: 86 24 62786318
Website: <http://www.panasonicbattery.cn>

2011.12