

RECHARGEABLE BATTERY : Nickel Metal Hydride

Document Title: RB003100

NH-AAA1000

Dimensions:

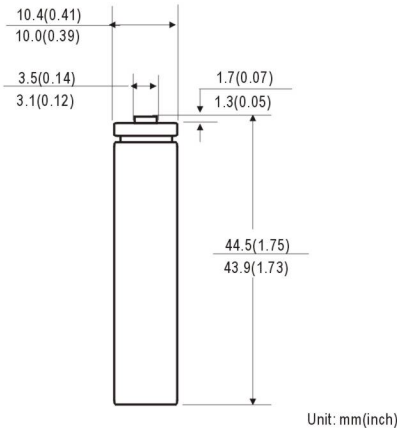

Chemical System	: Nickel Metal Hydride
Camelion Model	: NH-AAA1000
Average Weight	: 14.0g
Dimension (Ø x H)	: 10.2 ^{+0.2} x 44.2 ^{+0.3} mm (0.40 ^{+0.01} x 1.74 ^{+0.01} inch)
Nominal Voltage	: 1.2 Volts
Nominal Internal Resistance	: 28m-ohm @ 1kHz
Capacity (200mA constantly discharge to 1.0V at 20±2°C)	
Typical	: 1000mAh
Minimum	: 850mAh
Max. Charge Current	: 1000mA
Max. Discharge Current	: 2000mA
Relative Humidity	: 65±20%
Jacket	: PVC Label

Fast Charge Characteristics

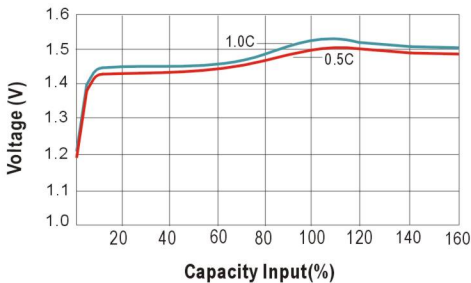

Charging Conditions

Mode	Current	Time	Temperature
Standard	100mA	16.0hrs	0°C~45°C
Quick	500mA	2.4hrs	10°C~45°C
Fast	1000mA	1.2hrs*	10°C~45°C
Trickle	26~40mA	Continuously	10°C~35°C

*Can also be controlled with - ΔV or dT/dt system
- ΔV : 0-10mV
dT/dt : 0.8°C/min(0.5C to 0.9C)
0.8-1.0°C/min(1C)
Timer cut off : 120% nominal capacity
Temp. cut off : 55°C

Continuous Overcharge

100mA maximum current for 28 days
No conspicuous deformation and/or leakage

Operating and Storage Temperatures

Charge at 0.1C : 0°C to 50°C (32°F to 122°F)
Discharge at 0.1C : -20°C to 50°C (-4°F to 122°F)
Storage : -40°C to 50°C (-40°F to 122°F)
(3 Months Max.)
-20°C to 35°C (-4°F to 95°F)
(2 Years Max.)

Service Life

>500 cycles (IEC standard)
Up to 1000 cycles (not less than 60% of nominal at 0.1C Charge/0.2C discharge)

Discharge Characteristics

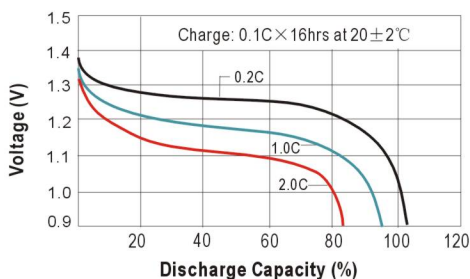

Notice:

Environmental elements comply with RoHS requirements. This information is subject to change without prior notice and for reference only. It should not be used as a basis for a product guarantee or warranty. For additional information, please consult your nearest Camelion Sales Office or Distributor or visit our website at: www.camelionbattery.com.