

UP-PW1245P

DIMENSIONS (MM)

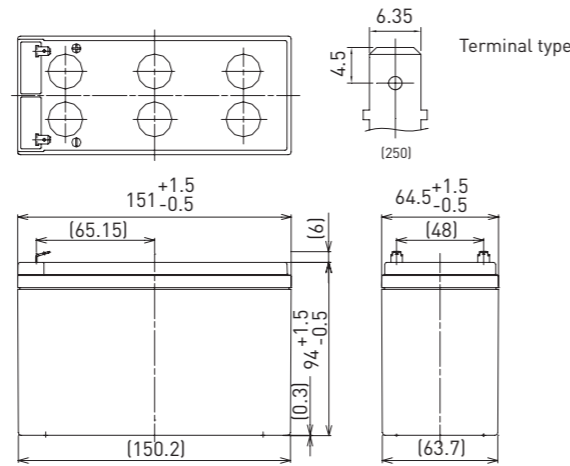

FOR STANDBY POWER SUPPLIES.  
EXPECTED TRICKLE DESIGN LIFE: 10 - 12 YEARS AT 20°C  
ACCORDING TO EUROBAT.



Contents indicated (including the recycle marking, etc.) are subject to change without notice.

Battery case resin: flame retardant (UL94 V-0)

SPECIFICATIONS

Name	UP-PW1245P1
Nominal voltage	12V
Rated power (cell@10MR)	270W
Dimensions	Length 151mm
	Width 64.5mm
	Height 100mm
Approx. mass	2.55kg
Terminal	Faston 250
Capacity (25°C)	30 minute rate 112W
	15 minute rate 195W
	10 minute rate 270W
	5 minute rate 410W
Impedance	Fully charged battery (25°C) 20mΩ
	40°C 102%
Temperature dependency of capacity (20 hour rate)	25°C 100%
	0°C 85%
	-15°C 65%
Self-discharge (25°C)	After 3 month 91%
	After 6 month 82%
	After 12 month 64%

DURATION OF DISCHARGE VS. DISCHARGE CURRENT

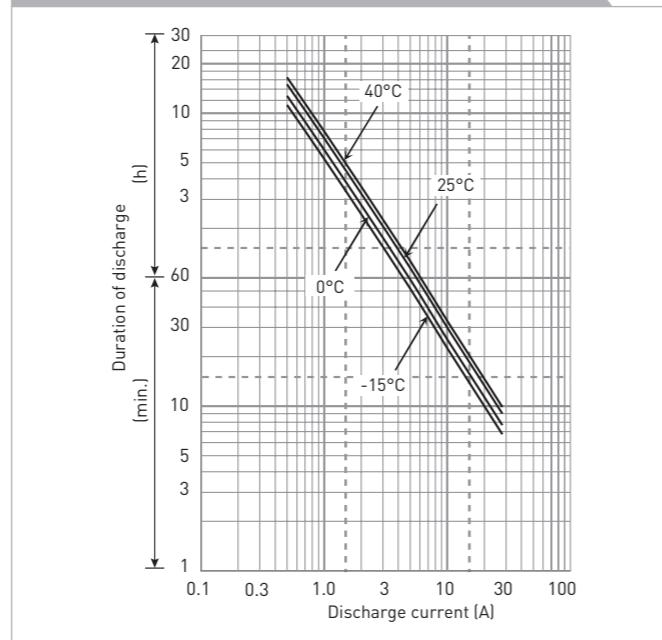

WATT TABLE (25°C)

Cut-off	Duration (h)															
	3min.	5min.	10min.	15min.	20min.	30min.	45min.	1h	1.5h	2h	3h	4h	5h	6h	10h	20h
9.6V	530	410	270	195	159	112	82.1	65.7	45.2	34.9	26.0	20.0	16.5	13.3	8.79	4.76
9.9V	509	400	263	194	158	111	81.6	65.1	44.3	34.7	25.9	19.8	16.4	13.2	8.75	4.75
10.2V	490	390	258	193	156	110	80.8	64.4	43.4	33.9	25.6	19.7	16.2	13.1	8.65	4.73
10.5V	463	360	246	187	151	109	78.7	63.0	41.7	32.8	25.2	19.5	16.1	13.0	8.62	4.72
10.8V	434	330	234	180	146	108	78.3	61.8	41.3	31.1	24.7	19.3	15.7	12.7	8.52	4.69

AMPERE TABLE (25°C)

Cut-off	Duration (h)															
	3min.	5min.	10min.	15min.	20min.	30min.	45min.	1h	1.5h	2h	3h	4h	5h	6h	10h	20h
9.6V	47.7	36.8	23.9	17.0	13.7	9.57	6.99	5.57	3.82	2.95	2.19	1.67	1.38	1.11	0.732	0.397
9.9V	45.8	35.9	23.5	16.9	13.6	9.55	6.95	5.50	3.75	2.93	2.17	1.66	1.37	1.10	0.729	0.396
10.2V	44.1	35.0	23.0	16.8	13.5	9.49	6.88	5.46	3.67	2.86	2.15	1.65	1.36	1.09	0.721	0.394
10.5V	41.6	32.3	22.0	16.3	13.0	9.40	6.70	5.35	3.53	2.77	2.11	1.64	1.35	1.08	0.718	0.393
10.8V	39.0	29.6	20.9	15.7	12.6	9.32	6.67	5.25	3.50	2.62	2.08	1.62	1.31	1.06	0.710	0.391

All mentioned values are average values

UP-PW1245P

CHARGING METHOD (25°C)

Trickle use Control voltage: 13.6V - 13.8V  
Initial current: 1.2A or smaller

CUT-OFF VOLTAGE

Discharge current	0.4A - 1.6A	1.6A - 4A	4A - 8A	8A - 16A	16A - 24A
Cut-off voltage	10.5V	10.2V	9.9V	9.3V	8.7V

INFLUENCE OF TEMPERATURE ON TRICKLE LIFE

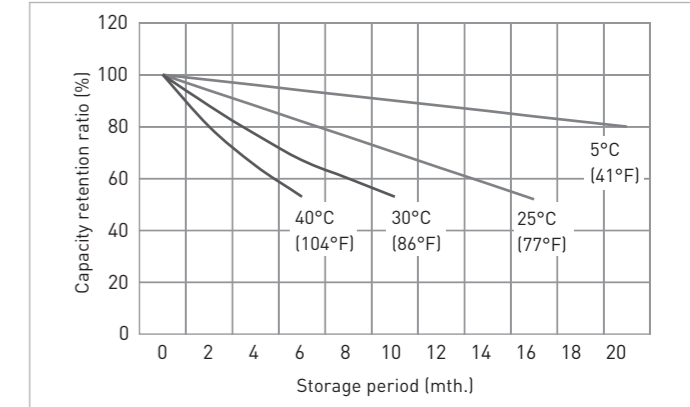
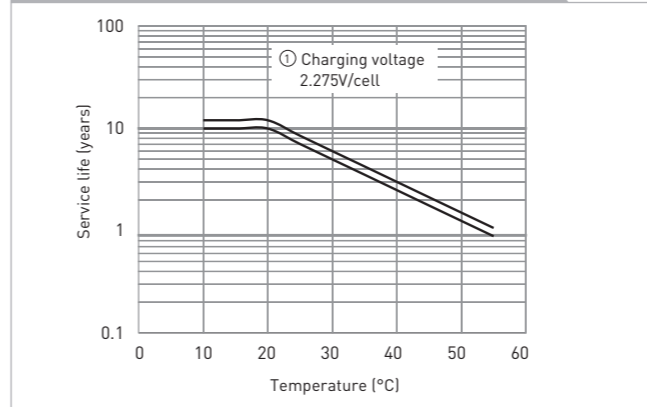

CONSTANT-VOLTAGE CONSTANT-CURRENT CHARGE CHARACTERISTICS FOR TRICKLE USE

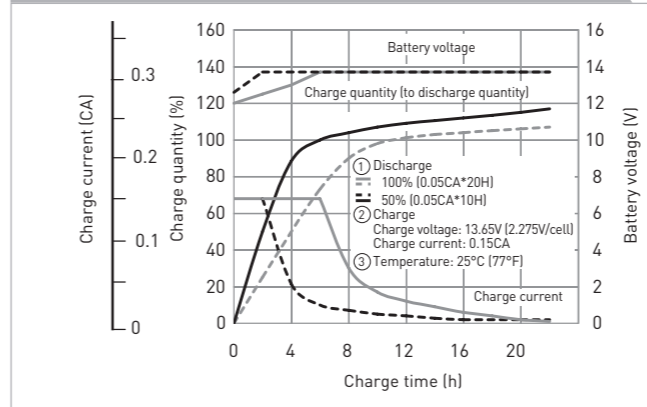

DISCHARGE CAPACITY BY TEMPERATURE AND BY DISCHARGE CURRENT

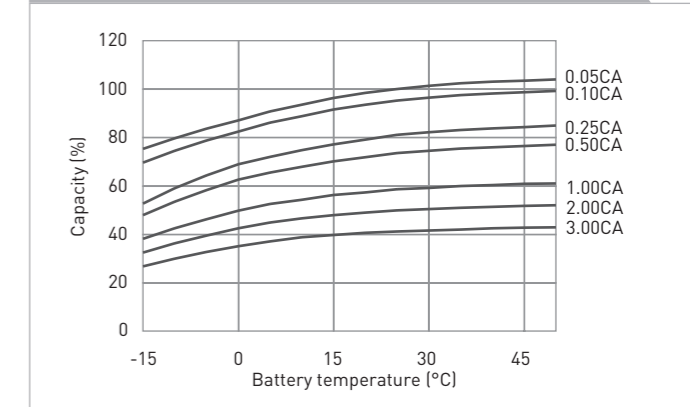

DISCHARGE CHARACTERISTICS

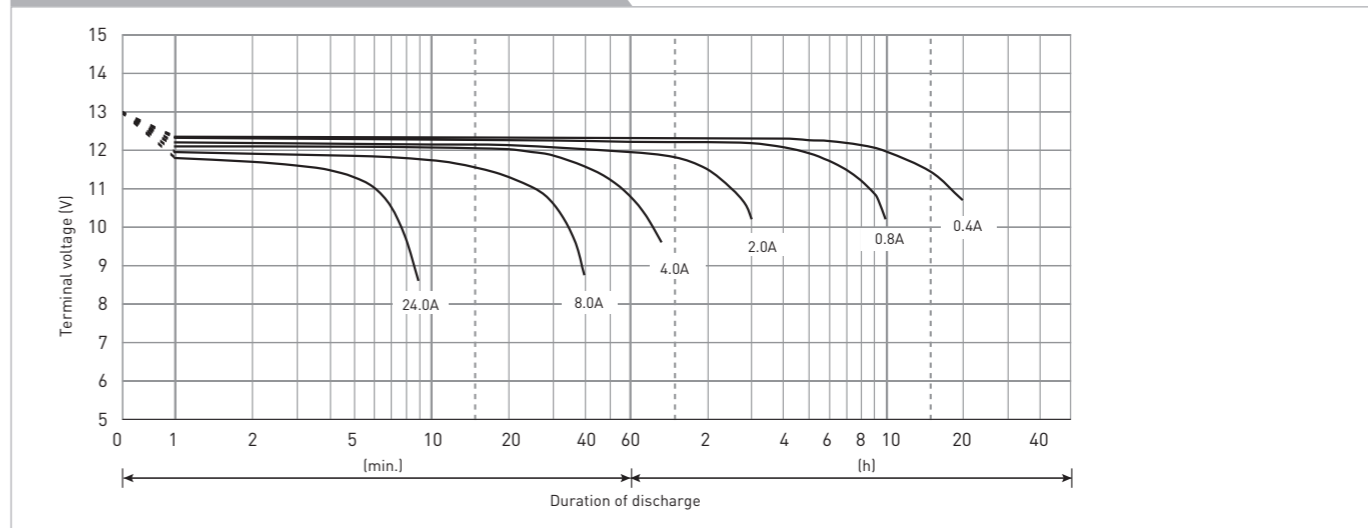

The data in this document are for descriptive purposes only and are not intended to make or imply any guarantee or warranty. Regarding handling and safety please consult our VRLA technical handbook chapter 1.