

CR-1025

DIMENSIONS (MM)

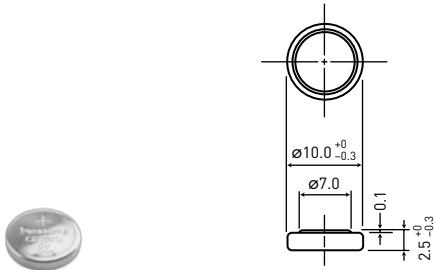

Model number	CR-1025
Nominal voltage (V)	3
Nominal capacity (mAh)	30
Diameter (mm)	10.0
Total height (mm)	2.5
Discharging temperature range (°C)	-30 to +60
Weight (g)	0.7

DISCHARGE TEMPERATURE CHARACTERISTICS

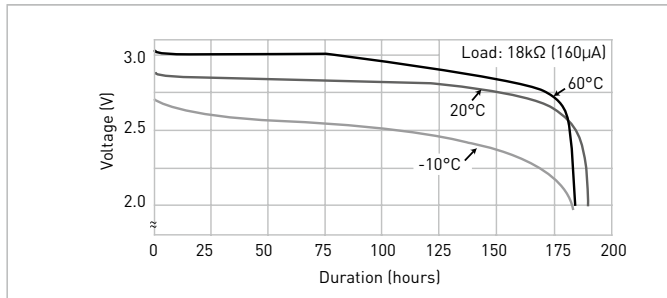

OPERATING VOLTAGE VS. DISCHARGE CURRENT*1

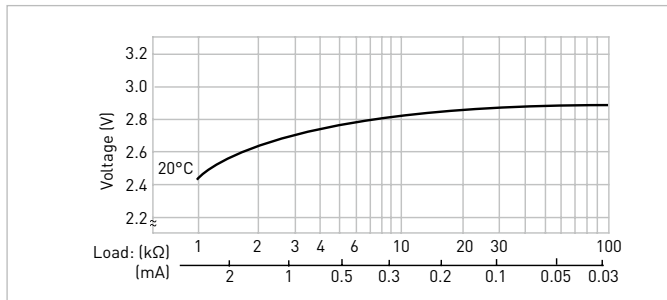

CAPACITY VS. LOAD RESISTANCE

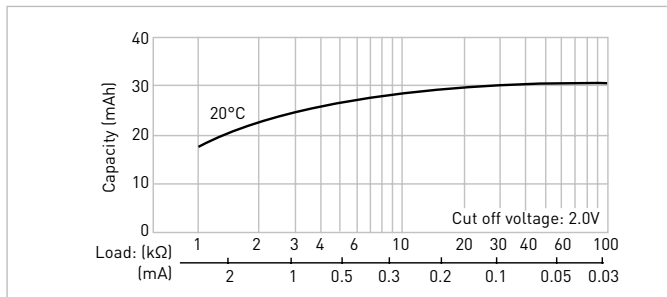

CR-1216

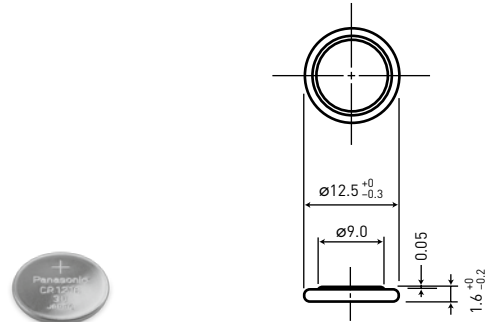

Model number	CR-1216
Nominal voltage (V)	3
Nominal capacity (mAh)	25
Diameter (mm)	12.5
Total height (mm)	1.6
Discharging temperature range (°C)	-30 to +60
Weight (g)	0.7

DISCHARGE TEMPERATURE CHARACTERISTICS

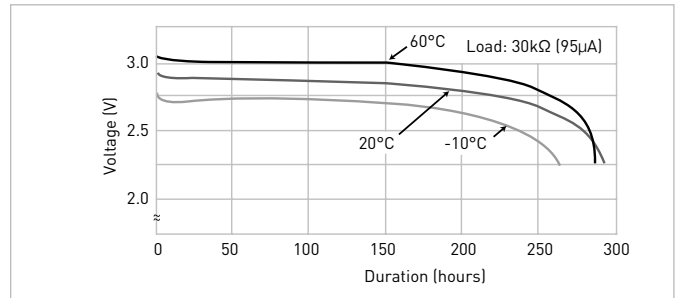

OPERATING VOLTAGE VS. DISCHARGE CURRENT*1

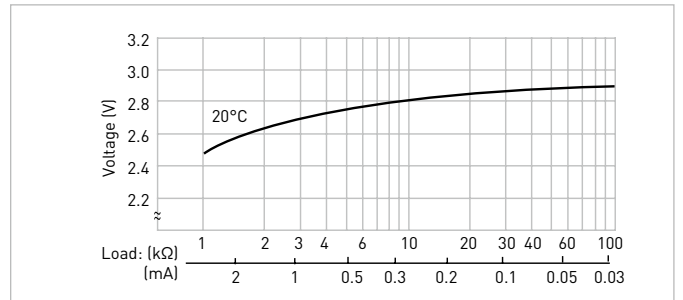

CAPACITY VS. LOAD RESISTANCE

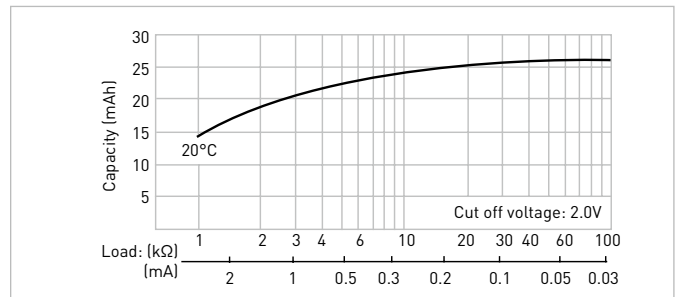

The data in this document are for descriptive purposes only and are not intended to make or imply any guarantee or warranty.

*1 Voltage at 50% discharge depth.