

LC-T1270P

DIMENSIONS (MM)



Contents indicated (including the recycle marking, etc.) are subject to change without notice.

FOR ENERGY STORAGE APPLICATIONS.
CYCLE LONG-LIFE TYPE

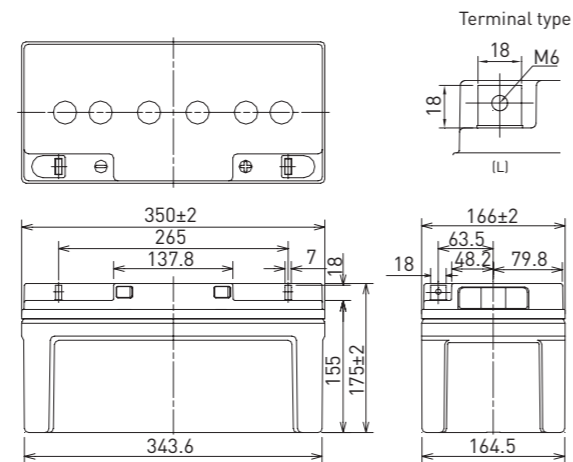

Battery case resin: standard (UL94 HB)

SPECIFICATIONS

Name		LC-T1270P
Nominal voltage		12V
Nominal capacity (20 hour rate)		70Ah
Dimensions	Length	350mm
	Width	166mm
	Height	175mm
Approx. mass		24.5kg
Terminal		M6 bolt/nut
Capacity (25°C)	20 hour rate	70Ah
	10 hour rate	66Ah
	3 hour rate	56Ah
	1 hour rate	43Ah
Impedance		Fully charged battery (25°C) 6mΩ
Temperature dependency of capacity (20 hour rate)	40°C	102%
	25°C	100%
	0°C	85%
	-15°C	65%
Self-discharge (25°C)	After 3 month	91%
	After 6 month	82%
	After 12 month	64%

DURATION OF DISCHARGE VS. DISCHARGE CURRENT

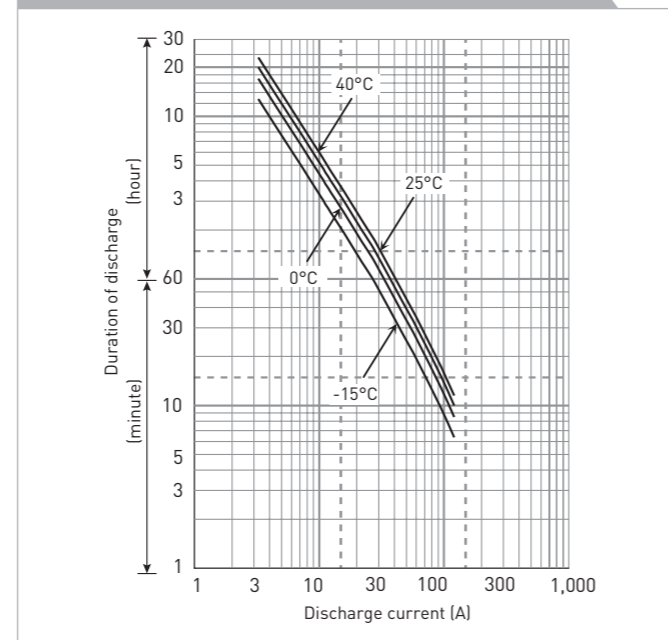

WATT TABLE (25°C)

Cut-off	[Wattage/battery]														
	5min.	10min.	15min.	20min.	30min.	45min.	1h	1.5h	2h	3h	4h	5h	6h	10h	20h
9.6V	2,312	1,815	1,391	1,078	855	662	504.0	387.0	303.0	241.9	170.0	142.0	126.0	80.90	43.70
9.9V	2,245	1,779	1,364	1,073	846	651	491.0	379.0	295.0	237.2	166.0	138.0	122.0	78.10	43.40
10.2V	2,179	1,745	1,337	1,055	836	639	477.0	368.4	287.0	230.3	163.0	134.0	118.0	75.50	43.20
10.5V	2,116	1,710	1,311	1,002	817	621	464.0	361.1	283.0	217.0	159.0	130.0	115.0	75.20	40.50
10.8V	2,054	1,677	1,285	956	774	609	458.0	350.6	276.0	210.7	155.0	128.0	113.0	73.70	39.80

AMPERE TABLE (25°C)

Cut-off	[Ampere/battery]														
	5min.	10min.	15min.	20min.	30min.	45min.	1h	1.5h	2h	3h	4h	5h	6h	10h	20h
9.6V	251	175	130	105	79.2	59.6	47.3	36.5	27.4	20.3	15.0	12.6	10.5	6.65	3.56
9.9V	244	172	127	102	77.6	58.4	45.9	35.5	27.3	19.7	14.9	12.2	10.2	6.63	3.53
10.2V	239	167	125	101	76.1	56.7	44.5	34.6	27.2	19.1	14.8	11.9	10.1	6.62	3.52
10.5V	229	162	123	98	74.9	55.1	43.3	33.9	26.5	18.6	14.7	11.8	10.0	6.55	3.50
10.8V	203	159	119	95	72.3	54.2	42.0	33.0	25.2	18.2	14.5	11.5	9.80	6.50	3.49

All mentioned values are average values

LC-T1270P

CHARGING METHOD (25°C)

Cycle use Control voltage: 14.5V - 14.9V
Initial current: 28.0A or smaller

CUT-OFF VOLTAGE

Discharge current	3.5A - 14.0A	14.0A - 35A	35A - 70.0A	70A - 140A	140A - 210A
Cut-off voltage	10.5V	10.2V	9.9V	9.3V	8.7V

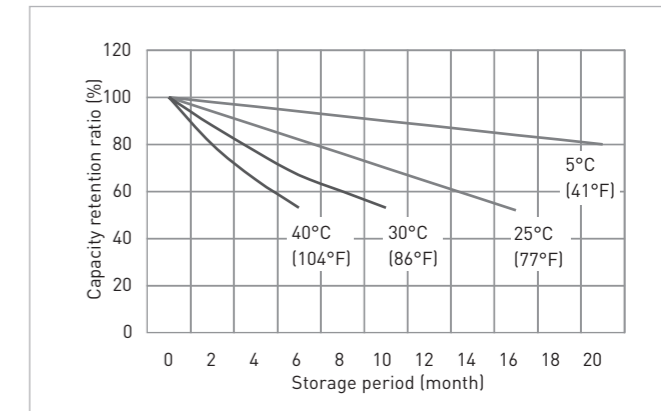
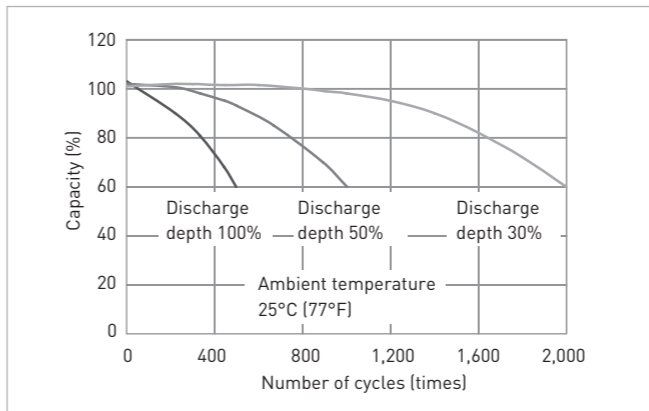

CONSTANT-VOLTAGE CONSTANT-CURRENT CHARGE CHARACTERISTICS FOR CYCLE USE

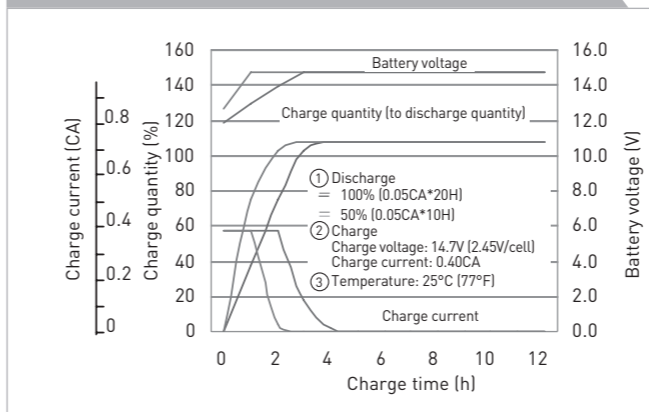

DISCHARGE CAPACITY BY TEMPERATURE AND BY DISCHARGE CURRENT

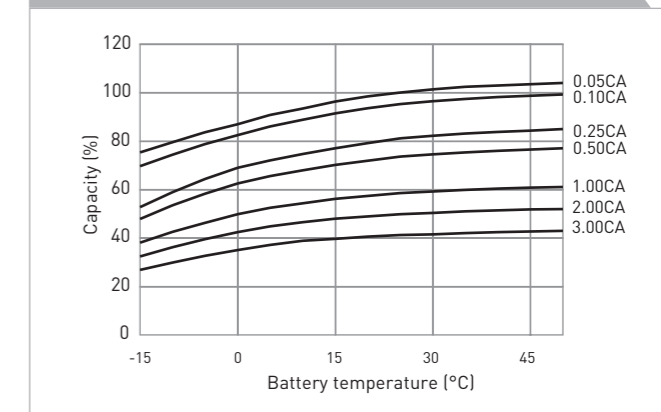

DISCHARGE CHARACTERISTICS

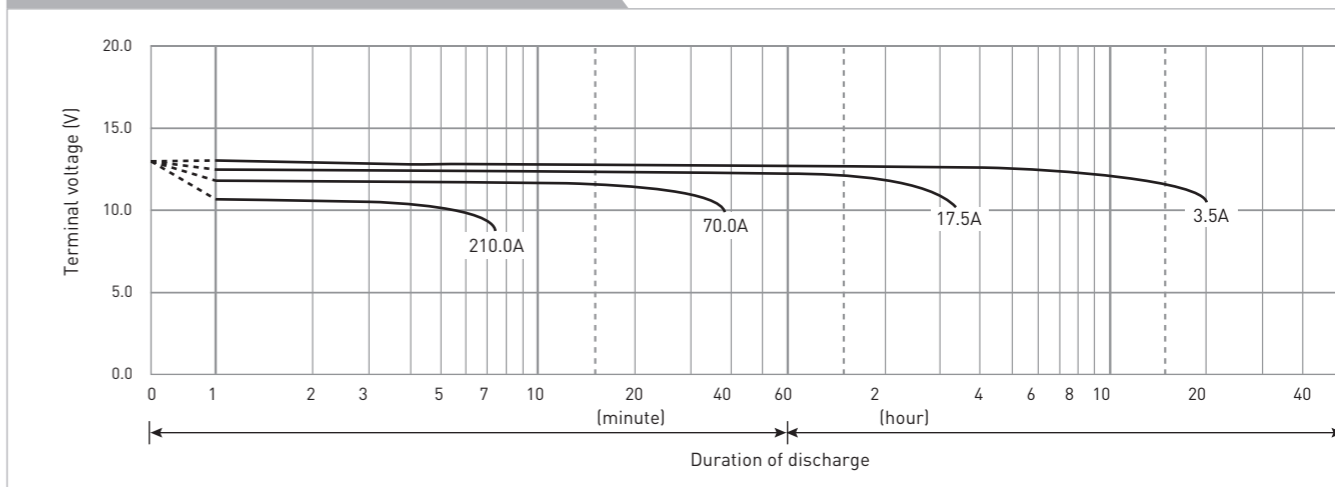

The data in this document are for descriptive purposes only and are not intended to make or imply any guarantee or warranty. Regarding handling and safety please consult our VRLA technical handbook chapter 1.