

LC-R061R3P\*1

DIMENSIONS (MM)

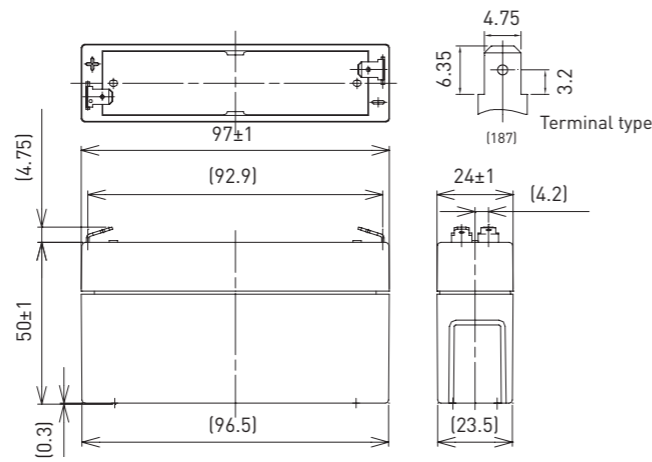

FOR MAIN AND STANDBY POWER SUPPLIES.  
EXPECTED TRICKLE DESIGN LIFE: 6 - 9 YEARS AT 20°C  
ACCORDING TO EUROBAT.



Contents indicated (including the recycle marking, etc.) are subject to change without notice.

Battery case resin: standard (UL94 HB)

SPECIFICATIONS

Name	LC-R061R3P*1
Nominal voltage	6V
Nominal capacity (20 hour rate)	1.3Ah
Dimensions	Length: 97mm
	Width: 24mm
	Height: 55mm
Approx. mass	0.25kg
Terminal	Faston 187
Capacity (25°C)	20 hour rate: 1.3Ah
	10 hour rate: 1.2Ah
	3 hour rate: 1.1Ah
Impedance	Fully charged battery (25°C): 50mΩ
	40°C: 102%
	25°C: 100%
Temperature dependency of capacity (20 hour rate)	0°C: 85%
	-15°C: 65%
	Self-discharge (25°C)
	After 6 month: 82%
	After 12 month: 64%

DURATION OF DISCHARGE VS. DISCHARGE CURRENT

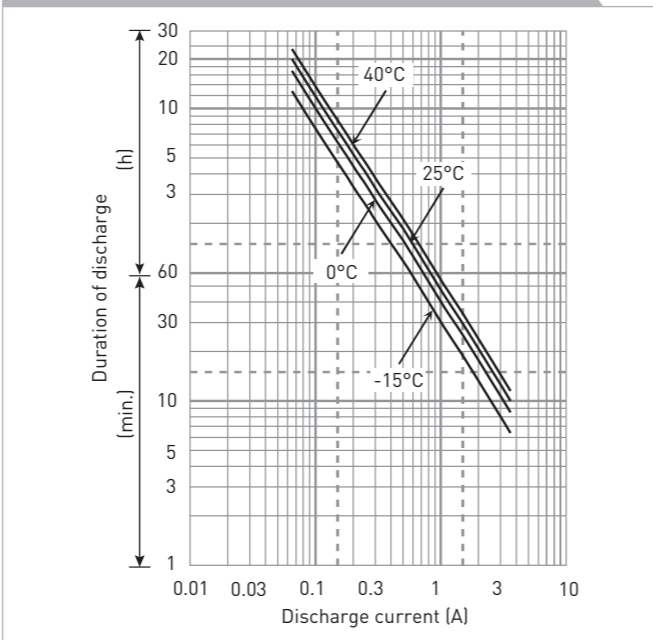

WATT TABLE (25°C)

Cut-off	(Wattage/battery)															
	3min.	5min.	10min.	15min.	20min.	30min.	45min.	1h	1.5h	2h	3h	4h	5h	6h	10h	20h
4.80V	39.1	30.8	20.1	15.4	12.9	9.61	6.78	5.42	3.73	2.89	2.15	1.65	1.36	1.10	0.726	0.393
4.95V	36.2	28.9	19.7	15.3	12.7	9.51	6.74	5.37	3.66	2.86	2.14	1.64	1.35	1.09	0.723	0.392
5.10V	33.4	27.1	19.2	15.0	12.5	9.40	6.68	5.32	3.58	2.79	2.12	1.63	1.34	1.08	0.715	0.391
5.25V	29.7	24.3	17.8	13.9	11.8	9.19	6.57	5.21	3.51	2.69	2.08	1.62	1.33	1.07	0.712	0.390
5.40V	25.1	21.4	15.9	13.0	11.5	8.87	6.47	5.10	3.41	2.57	2.04	1.60	1.30	1.05	0.704	0.388

AMPERE TABLE (25°C)

Cut-off	(Ampere/battery)															
	3min.	5min.	10min.	15min.	20min.	30min.	45min.	1h	1.5h	2h	3h	4h	5h	6h	10h	20h
4.80V	7.02	5.53	3.59	2.67	2.22	1.64	1.16	0.921	0.634	0.484	0.363	0.276	0.228	0.185	0.122	0.066
4.95V	6.52	5.18	3.52	2.65	2.18	1.63	1.15	0.912	0.621	0.480	0.361	0.274	0.226	0.184	0.121	0.065
5.10V	6.01	4.86	3.43	2.60	2.15	1.61	1.14	0.903	0.609	0.468	0.358	0.273	0.224	0.183	0.120	0.065
5.25V	5.34	4.35	3.18	2.42	2.04	1.57	1.12	0.885	0.596	0.451	0.352	0.272	0.222	0.182	0.119	0.065
5.40V	4.51	3.85	2.83	2.26	1.99	1.52	1.10	0.867	0.578	0.433	0.343	0.271	0.217	0.181	0.117	0.063

All mentioned values are average values

LC-R061R3P\*1

CHARGING METHOD (25°C)

Cycle use: Control voltage: 7.25V - 7.45V  
Initial current: 0.52A or smaller

CUT-OFF VOLTAGE

Discharge current	0.065A - 0.26A	0.26A - 0.65A	0.65A - 1.30A	1.30A - 2.60A	2.60A - 3.90A
Cut-off voltage	5.25V	5.10V	4.95V	4.65V	4.35V

CYCLE LIFE VS. DEPTH OF DISCHARGE (ACC. IEC 61056)

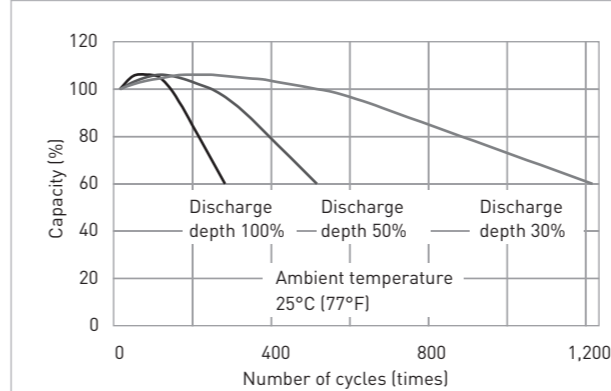

RESIDUAL CAPACITY TEST RESULT

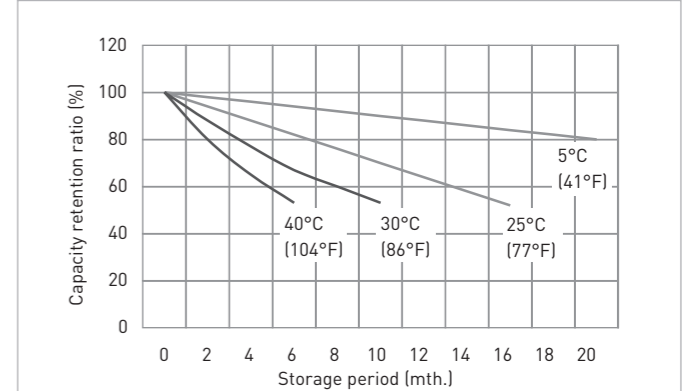

CONSTANT-VOLTAGE CONSTANT-CURRENT CHARGE CHARACTERISTICS FOR CYCLE USE

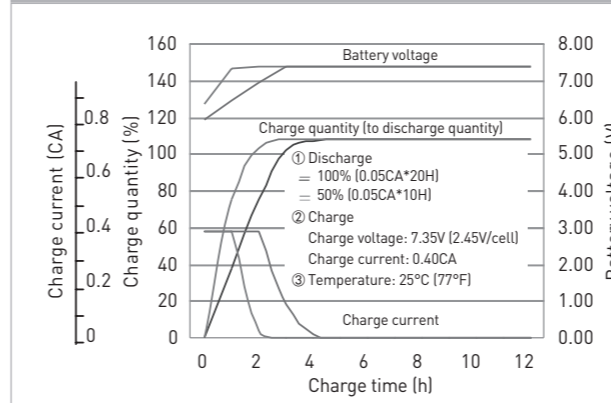

DISCHARGE CAPACITY BY TEMPERATURE AND BY DISCHARGE CURRENT

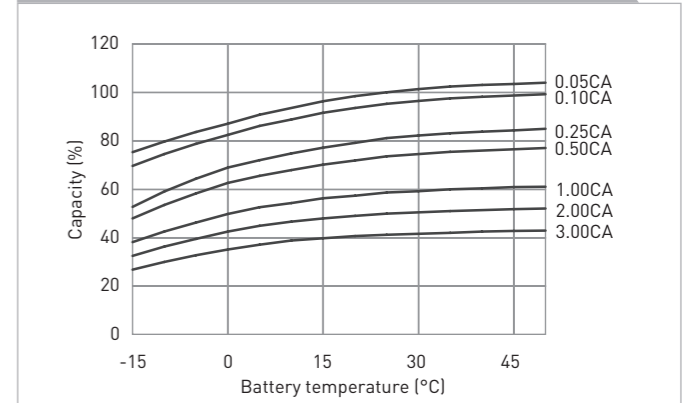

DISCHARGE CHARACTERISTICS

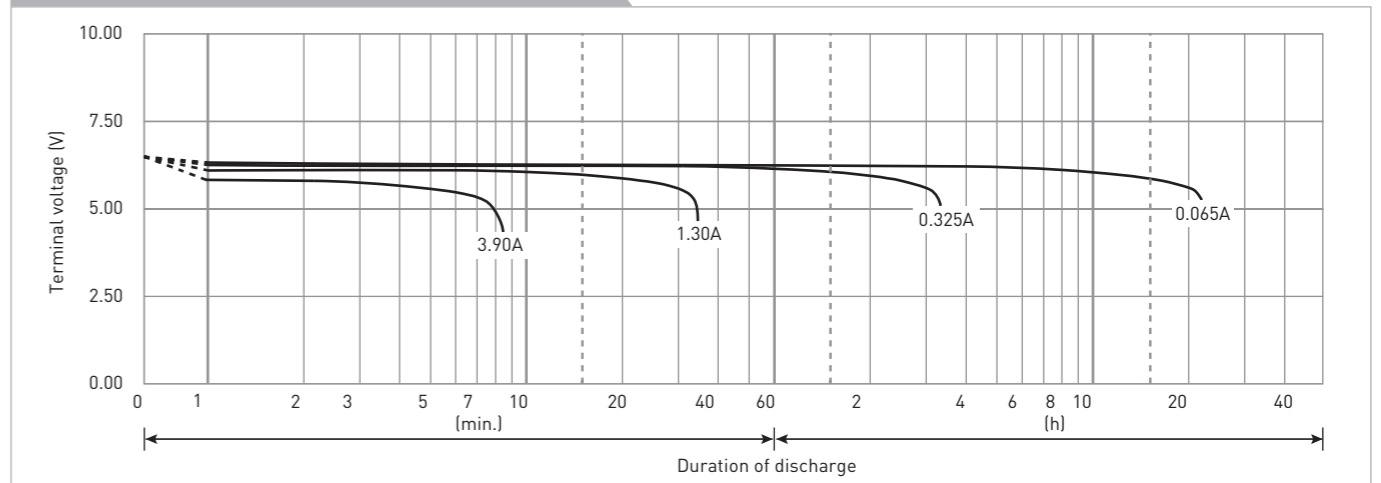

The data in this document are for descriptive purposes only and are not intended to make or imply any guarantee or warranty. Regarding handling and safety please consult our VRLA technical handbook chapter 1.